

VOLUMEN (l)
VOLUMEN (l)

MAX. OBREMENITEV (Kg)
MAX. OBTEREČENJE (Kg)

OBREMENITEV TAL (Kg/m²)
OBTEREČENJE PODA (Kg/m²)

240

390

260

- – Prostor za el. vodnik 3 x 2,5 mm² dolžine cca 1m.
- Mjesto za el. vodnik 3 x 2,5 mm² dužine cca 1m.
- – Prostor za el. vodnik 1 x 6 mm² za ozemljitev, dolžine cca 1,5m.
- Mjesto za el. vodnik 1 x 6 mm² za ozemljenje, dužine cca 1,5m.

- ⊠ – Priklop tople in hladne vode 1/2" min 0,2 Mpa, max 0,4 Mpa
- Priključak tople i hladne vode 1/2" min 0,2 Mpa, max 0,4 Mpa

- – Prostor za odtok ø 50 mm
- Mjesto za odtok ø 50 mm

- ⊠ – Opcija-obloga
- Opcija-obloga



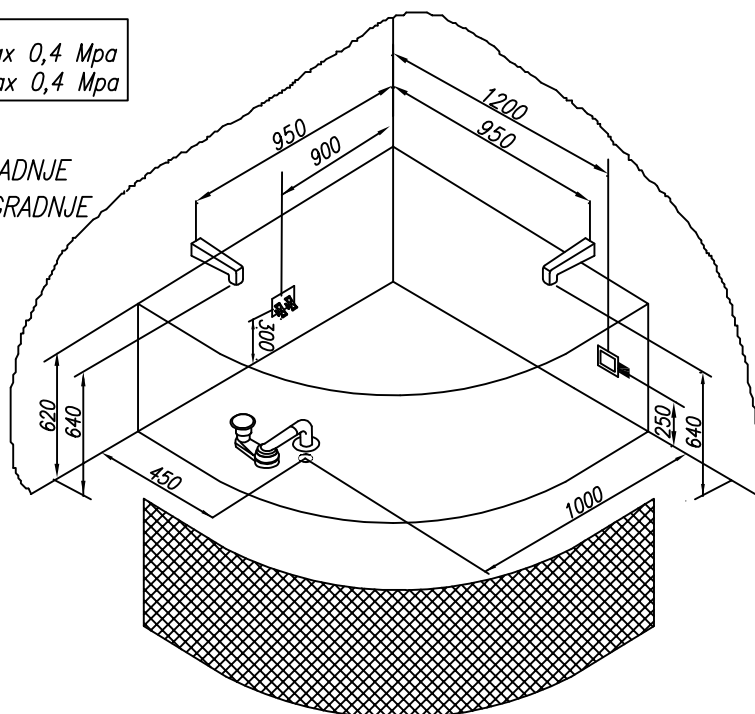



PREDLOG VGRADNJE
PRIJEDLOG UGRADNJE



Priporočena prelivna garnitura Preporuka prelivne garniture	PAL 450
Priporočila za vgradnjo kadi brez obloge Preporuka za ugradnjo kade bez obloge	Nr. MK 02
Priporočila za montažo kadi z oblogo Preporuka za ugradnju kade sa oblogom	Nr. MK 01
Opcija podnožja kadi za vgradnjo Varianta postolja za kade bez obloge	Nr. MK 07 1001/L
Opcija podnožja kadi z oblogo Varianta postolja za kade sa oblogom	Nr. MK 21 CD 140

DIVANTE 140x140

POLOŽAJ STIKAL IN AGREGATOV PRI RAZLIČNIH IZVEDBAH MASAŽNIH SISTEMOV MJESTO PREKIDAČA I AGREGATA KOT RAZLIČITIH IZVEDBI MASAŽNIH SISTEMA

- | | | | | |
|--|--|---|--|--|
|  - VODNA ČRPALKA
- CRPKA ZA VODU |  - VODNE ŠOBE
- VODENE MLAZNICE |  - REGULATOR ZRAKA
- REGULATOR ZRAKA |  - ELEKTRONSKA STIKALA
- ELEKTRONSKI PREKIDAČI |  - ARMATURA IN TUŠ ROČICA
- PIPA I TUŠ |
|  - ZRAČNI KOMPRESOR
- ZRAČNI KOMPRESOR |  - ZRAČNA ŠOBA
- ZRAČNA MLAZNICA |  - PNEVMATSKO STIKALO
- PNEVMATSKI PREKIDAČ |  - LUČ ALI CHROMOTERAPIJA
- SVJETLO ILI CHROMOTERAPIJA |  - PREKLOPNIK ZA MIKROŠOBE
- PREKIDAČ ZA MIKROMLAZNICE |

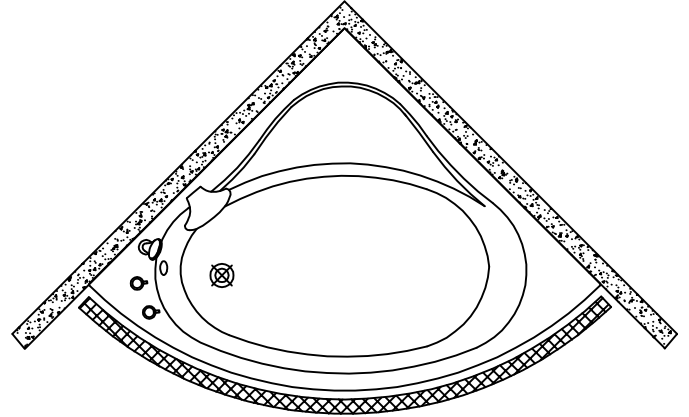
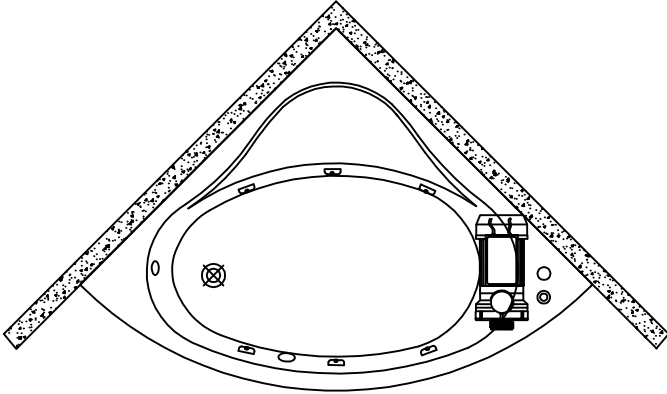

VODNI MASAŽNI SISTEM 1

- VODNA ČRPALKA P= 800W
- PNEVMATSKO STIKALO
- 6 VODNIH ŠOB
- REGULATOR ZRAKA

VODENI MASAŽNI SISTEM 1

- CRPKA ZA VODU P= 800W
- PNEVMATSKI PREKIDAČ
- 6 MLAZNICA ZA VODU
- REGULATOR ZRAKA

- OPCIJA ARMATURA IN TUŠ ROČICA
- OPCIJA PIPA I TUŠ

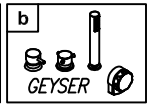
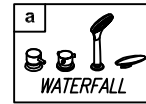
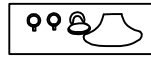

- OPCIJA OBLOGA KADI

- OPCIJA OBLOGA KADE

